



a  stainless technologies company

Diamond 3 Way Ball Valves







The DPL Diamond 3 Way Ball Valve has been designed to meet the demanding requirements of today's process industry.

Constructed from 316 Stainless Steel and built to the highest specification, the valve ball is fully encapsulated in PTFE, thus ensuring optimum levels of sanitation and cleanliness by nature of it's design.

Flow routing options of "T" port and "L" port are available from stock, thus ensuring that all common process application requirements are met. With options of end fitting, actuation and feedback the valves are suited to many industry sectors. These sectors include Food and Beverage, Pharmaceutical, Biomedical and Chemical.

Please call us to further discuss your requirements. We are confident that we have a valve designed to suit your application.

- Fully machined valve components in 316 grade stainless steel offering excellent corrosion resistance.
- PTFE Encapsulated valve ball ensures optimum levels of sanitation and cleanliness.
- "L" Port and "T" port options available to ensure maximum application suitability.
- Optional actuation package available including feedback switches and solenoid options to provide a full automation solution.
- Direct mount ISO pad for ease of actuation.
- Wide selection of end fittings available, thus ensuring maximum compatibility with your system.
- Lockable handle for optional security.

| "L" PORT POSITIONS | | | | "T" PORT POSITIONS | | | |
|---|---|---|---|---|---|---|---|
| 1 | 2 | 3 | 4 | 1 | 2 | 3 | 4 |
|  |  |  |  |  |  |  |  |

TECHNICAL DATA

- Seat Material: PTFE
- Standard Internal Finish: <1.0um
- Maximum Operating Pressure: 10 Bar
- Wetted Part Construction: 316 Stainless Steel
- Standard End Connections: Butt Weld, RJT, IDF, Clamp, ILC, DIN, Flange
- (other end connection options available upon request)

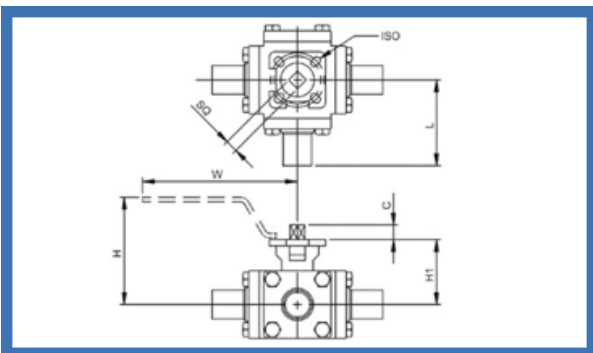

FULL DIMENSIONS ARE AVAILABLE UPON REQUEST

| | 0.5" | 0.75" | 1.0" | 1.5" | 2.0" | 2.5" | 3.0" |
|-----------------------|------|-------|------|------|------|------|------|
| Break-out Torque (Nm) | 4 | 4 | 10 | 23 | 41 | 68 | 128 |
| Running Torque (Nm) | 3 | 3 | 7 | 15 | 23 | 38 | 75 |

(25% Safety Factor included)

Dairy Pipe Lines Ltd. Tipton Road, Dudley. DY1 4SQ
Tel: +44 (0)1799 522 885
Email: dairypipelines@dpluk.co.uk **www.dpluk.co.uk**